

For Installers

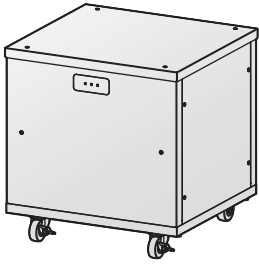

TABUCHI ELECTRIC

Installation Manual

Lithium-ion Storage Battery Unit (Home-use, 9.89 kWh)

Model Number : EOW-LB100-PNUS2

Thank you for purchasing this product from Tabuchi Electric.

- Read this Installation Manual carefully to ensure precise and safe installation. Especially, familiarize yourself with the “Safety Precautions” (Page 2) before using this product.
- Tabuchi Electric is not responsible for any accidents or damage caused by methods not specifically described in this Installation Manual or use of unspecified parts.
- Electrical wiring should be performed by a licensed electrician in accordance with technical standards for electrical equipment and internal wiring codes.
- Keep this Installation Manual together with the User’s Manual in a safe handy place for future reference.

Table of Contents

| | |
|---------------------------|----|
| Safety Precautions | 2 |
| Installation Precautions | 3 |
| Installation Procedure | 3 |
| System Diagram | 4 |
| External Dimensions | 5 |
| Parts (Names & Functions) | 6 |
| Prior Confirmation | 7 |
| Wiring Work | 8 |
| Specifications | 11 |
| FCC Compliance | 11 |



Safety Precautions



Observe all safety precautions.



- Carefully read this Installation Manual prior to installation. Follow all safety precautions and instructions.
- All electrical work should be completed by a licensed electrician.
- Tabuchi Electric assumes no responsibility for accidents or equipment failure if the equipment is handled, installed or used in disregard of precautions.
- If anything strange is noticed during installation, stop work and contact the vendor or Tabuchi Electric.
- Use only the accessories and parts provided or specified in this Installation Manual for installation and wiring.
- Do not install or modify the equipment in any way that is not described in this Installation Manual.



■ The symbols below indicate the potential hazards of improper installation or use of this product.

■ The symbols below indicate prohibited use of this product and mandatory safety precautions.

| | |
|--|--|
|  WARNING | May result in serious injury or death. |
|  CAUTION | May result in minor injury or property damage. |

| | |
|---|---------------------------------|
|  | Prohibited use of this product. |
|  | Mandatory safety precautions. |

|  WARNING | | | |
|--|--|--|---|
|  PROHIBITED USE | <ul style="list-style-type: none"> • Do not disassemble or remodel the storage battery unit. This may result in fire, electric shock, current leaks, or equipment failure. • Do not install the storage battery unit outdoors or where it will be exposed to high humidity, steam, vapor, cold air, oily mist, or dust. This may result in fire, electric shock, current leaks, or equipment failure. |  MANDATORY | <ul style="list-style-type: none"> • During installation and wiring work, follow all safety precautions because this equipment uses direct current and high voltage. Failure to do so may result in electric shock or equipment failure. • Keep all switches in the OFF position until wiring work is completed. This includes all switches in the junction box, the stand-alone output breaker in the power station, the grid-tied breaker in the home breaker box and the switch inside the storage battery unit. • Confirm there is no live voltages before commencing installation work. • Do not stand on wet ground or work with wet hands or body parts. • Do not damage the wire sheathing. |
| | <ul style="list-style-type: none"> • Electrical work should be done correctly and safely in accordance with technical standards for electrical equipment and workplace health and safety laws. Improper installation may result in fire, electric shock, or injury. • Wear protective gloves and use electrically insulated tools during installation and when installing electrical wiring work. Unprotected hands may result in electric shock, injury or equipment failure. | | <ul style="list-style-type: none"> • Ground the equipment to ensure 100 Ω or less impedance against ground. Incomplete grounding may result in electric shock. • Do not short-circuit the positive (+) terminal cables (black) or negative (-) terminal cables (white) of the storage battery unit. Short-circuiting may cause a fire. |

|  CAUTION | | | |
|---|---|--|--|
|  PROHIBITED USE | <ul style="list-style-type: none"> • Do not drill or cut entry holes in the storage battery unit. Debris from drilling may adhere to the circuit boards resulting in fire or equipment failure. • Do not mix up the DC wires from the solar panels and the storage battery unit with the AC wires from the grid. Incorrect wiring may damage the equipment. |  MANDATORY | <ul style="list-style-type: none"> • Connect wiring securely to terminal blocks using the specified crimp terminal. Inadequate connections may result in equipment failure or cause an accident. |
| | <ul style="list-style-type: none"> • Install the storage battery unit on a surface that can withstand the weight of the product. Installation work should be completed by two or more qualified professionals. An inadequate installation site may result in equipment failure or cause an accident. | | <ul style="list-style-type: none"> • Be sure to observe all installation precautions (Page 3) and prior confirmation instructions (Page 7). Failure to do so may cause a fire or an accident. |

Installation Precautions

■ Do not install or connect the storage battery unit as described below.

- Do not connect to systems other than our inverter.
- Do not install outdoors.
- Do not install in locations where the storage battery unit may be exposed to rain, such as near windows.
- Do not install in locations where the ambient temperature is below -20°C (-4°F) or above 40°C (104°F).
(Avoid direct sunlight.)
- Do not install in highly humid areas such as lavatories, bathrooms, or kitchens.
(Humidity should be 85% or less.)
- Only install in locations with sufficient space and ventilation. (See “Installation Site” on Page 7.)
- Do not install in locations where the storage battery unit is or may be exposed to excessive steam, oily mist, smoke, dust, salt, corrosive materials, explosive/flammable gases, chemical agents or fire.
- Do not install in elevations exceeding 1000 meters (3281 ft).
- Do not install in locations where temperature fluctuates drastically and condensation occurs.
- Do not install in locations with stringent noise regulations.
(The actual noise level is about 30 dB or less. However, even at that level, the noise may be considered an annoyance. It is recommended that the unit be installed in a compartment that satisfies all of the required space conditions and installation requirements.)
- Do not install in locations where the storage battery unit may be subjected to vibrations or impacts.

Installation Procedure

Prior Confirmation

Page 7



Wiring Work

Page 8



Confirmation after installation is completed

Page 10

System Diagram

System Diagram

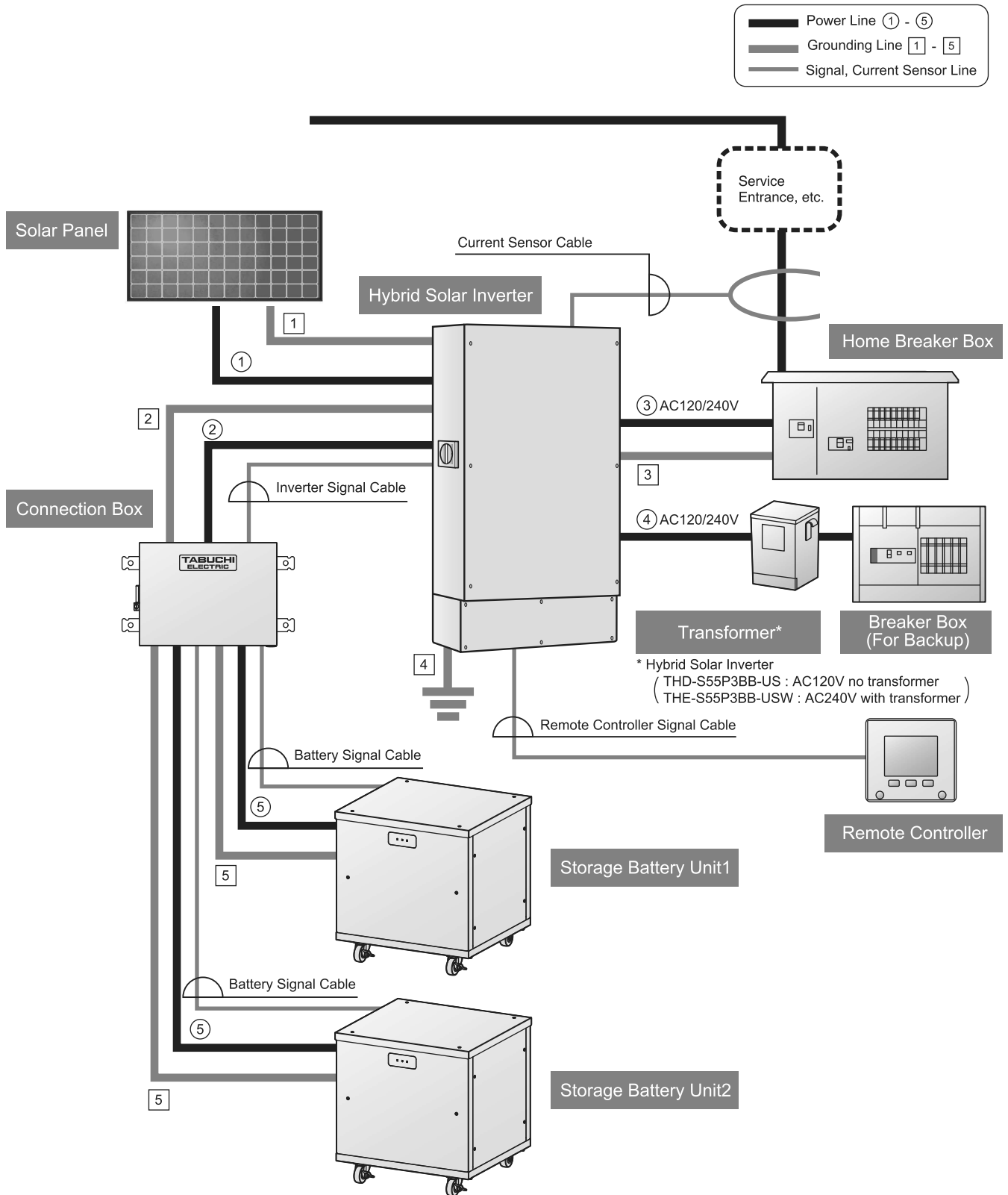

- * All parts except the storage battery unit are sold separately.
- * The remote control panel is included with the hybrid solar inverter (body).
- * Connection Box is used for the connection between 2 Storage Battery Units and 1 Hybrid Solar Inverter.

Included Parts

Check all parts included for any damage or defects.

■ Accessories

| Accessory | Qty | Accessory | Qty |
|---------------|-----|-------------------------------------|-----|
| User's Manual | 1 | Installation Manual (This document) | 1 |
| Caster Holder | 2 | Test Result | 1 |

■ Parts Supplied in Field

| | Power Wiring | Wiring Type and Gauge | Allowable Wiring Length | Recommended Crimping Lug |
|---|--|--|-------------------------|--------------------------|
| ① | Storage Battery Unit - Hybrid Solar Inverter (DC) | CV2 Conductors 5.5 mm ² | 15 m or less | R5.5-5 |
| | | CV2 Conductors 8 mm ² | 20 m or less | R8-5 |
| ② | Storage Battery Unit - Hybrid Solar Inverter (Grounding) | IV 1 Conductor ϕ 1.6(2mm ²) | | R2-5 |

External Dimensions

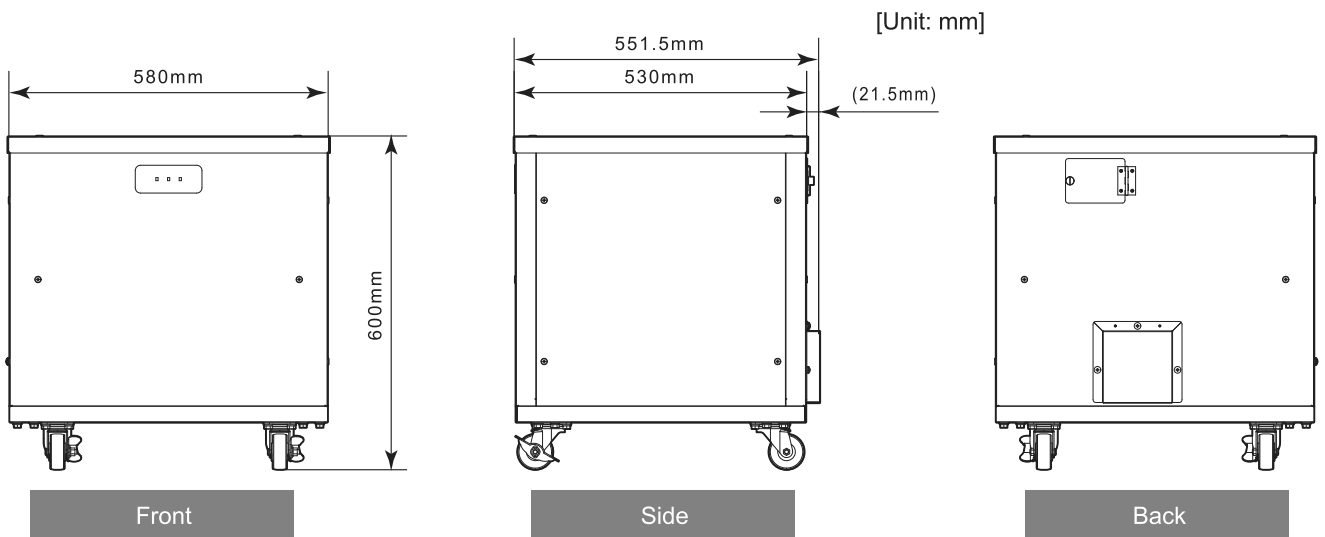

Parts (Names & Functions)

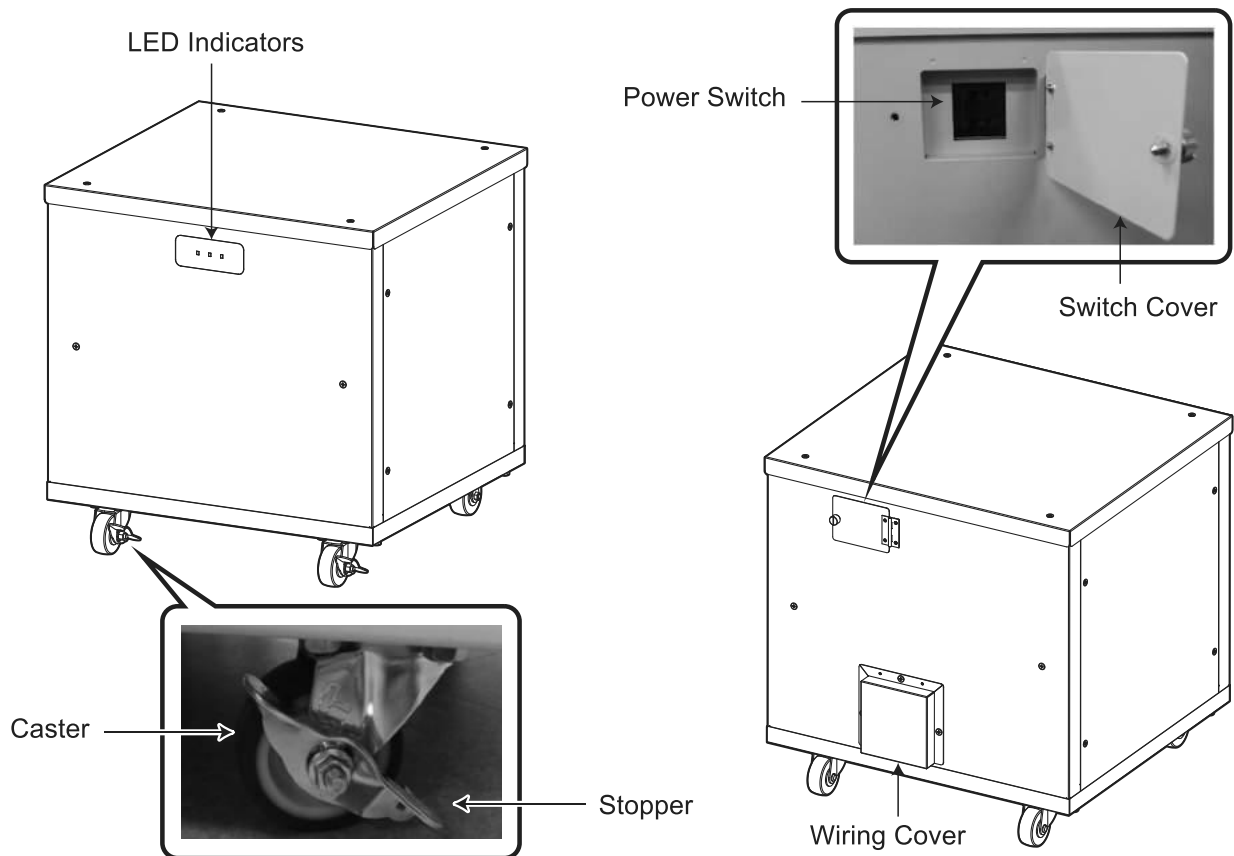

| | LED Indicators | Meaning |
|---------|--|---|
| OPERATE | <input type="checkbox"/> Green | Operating |
| | <input checked="" type="checkbox"/> Off | Switch is in the OFF position, Stopped due to error or for servicing. |
| | <input type="checkbox"/> Flashing Green | Servicing is required. |
| MODE | <input type="checkbox"/> Green | Charging |
| | <input type="checkbox"/> Orange | Discharging |
| | <input checked="" type="checkbox"/> Off | Charging/Discharging stopped |
| ALARM | <input type="checkbox"/> Single red flash | Ambient temperature issue detected. Check for heat sources and direct sunlight in the environment. Eliminate heat sources. |
| | <input type="checkbox"/> Double red flash | Minor error Check the condition of the wiring and devices. Monitor the situation. |
| | <input type="checkbox"/> Triple red flash | Communication error Eliminate any noise in the environment that prevents communication, restart the Hybrid solar inverter and monitor the situation. |
| | <input type="checkbox"/> Quadruple red flash | Material error Check the condition of the wiring and devices. Monitor the situation. |
| | <input checked="" type="checkbox"/> Off | Normal operation or operation stopped |

* If normal operation is not restored, contact Customer Support.

Prior Confirmation

Install the storage battery unit and the hybrid solar inverter at the same time.
For the installation of the Hybrid Solar Inverter, see the Installation Manual provided with the product.

Installation Site

Confirm that the installation site meets the following conditions:
Installing the storage battery unit in a site that does not meet these conditions may result in equipment failure or personal injury.

- (1) Can the floor withstand the weight of this unit (about 110 kg)?
- (2) Can the unit be installed level?
- (3) Can the sufficient ventilation and work space be secured?

(Secure the space shown in this diagram.)

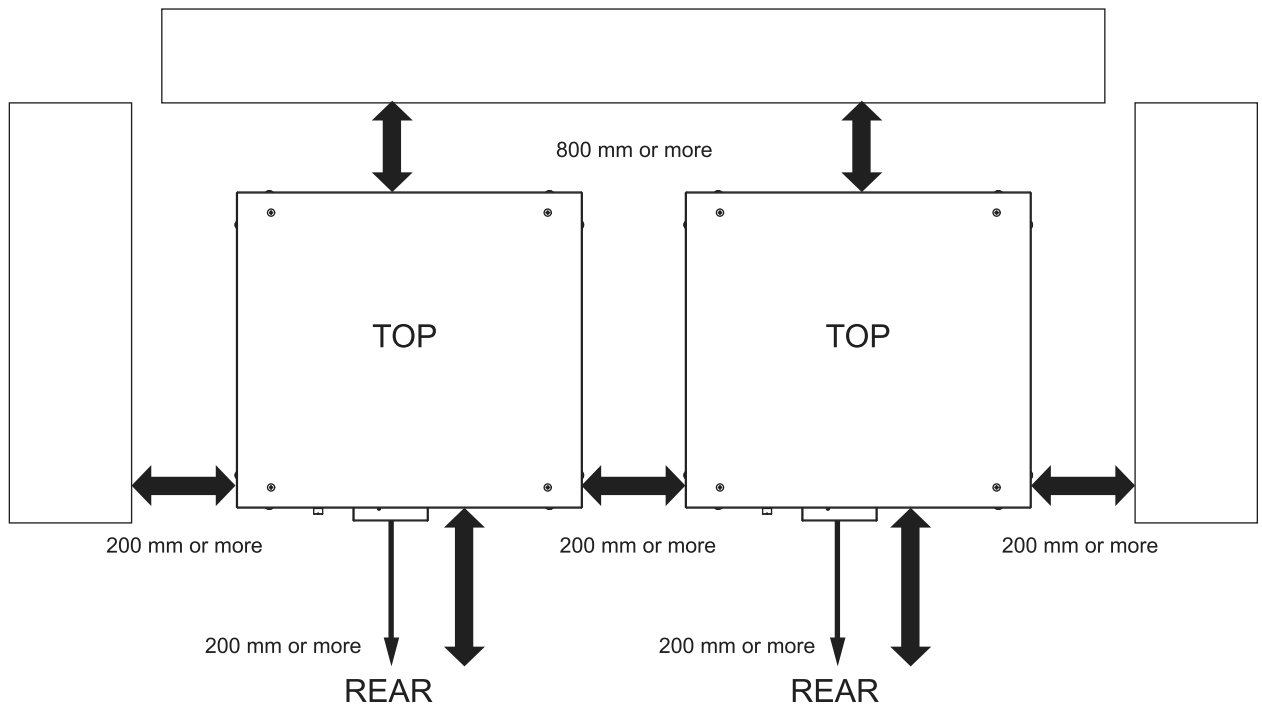
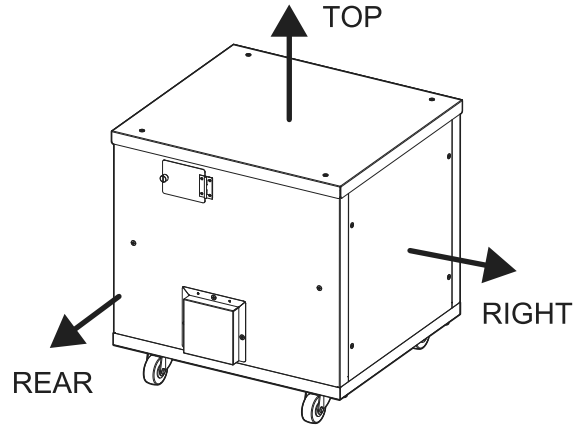

Breaker

Set grid-tied breaker in the home breaker box and the switch inside the storage battery unit in the OFF position.

Wiring Work

Caution

Supply power as explained in the Installation Manual of the Hybrid Solar Inverter. Supplying power over inadequate connections may result in inverter or battery storage unit trouble. (Tabuchi Electric is not responsible for any trouble with parts caused by incorrect connection or improper work. Such repairs can be offered at your expense.)

Wiring Connection

- Refer to the Hybrid Solar Inverter Installation Manual.
- Set all switches in the junction box, the solar power system grid-tied breaker in the home breaker box and the switch inside the storage battery unit to the OFF position.

To measure insulation resistance

CAUTION: Measuring the insulation resistance with the wires connected will damage the internal circuits. Do not conduct the insulation resistance test on the terminals.

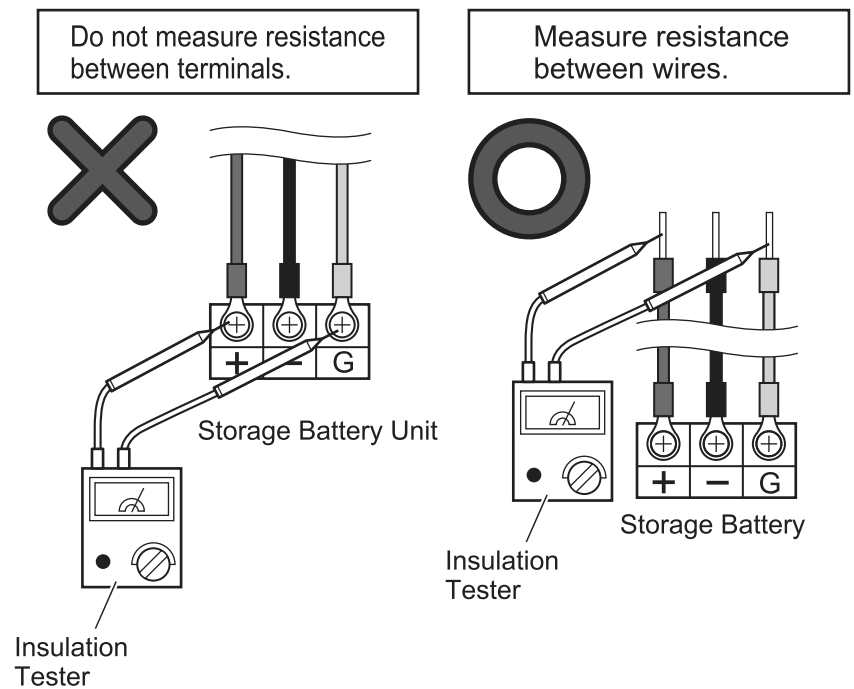

1 Remove the wiring cover from the back of the storage battery unit.

* Do not to lose the removed cover and screws.

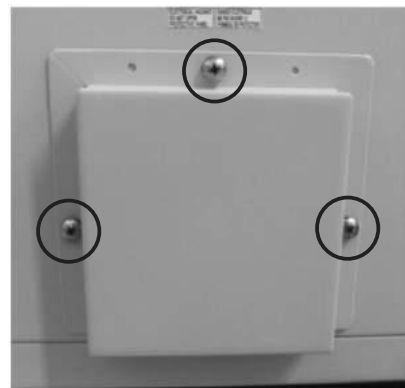

2 Attach the crimp terminal and insulating tube to the wire.

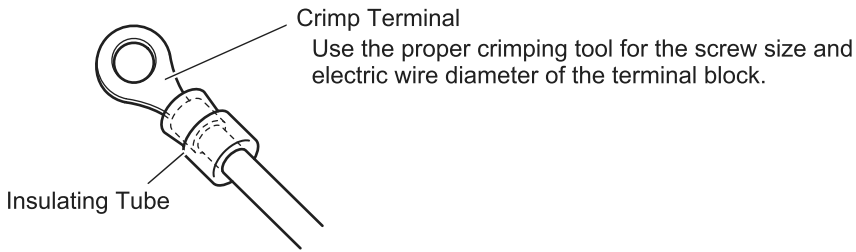

3 Connect the wires to the terminal block.

Connect them to G (Ground), Terminal (-), and Terminal (+) in the terminal block on the input side.

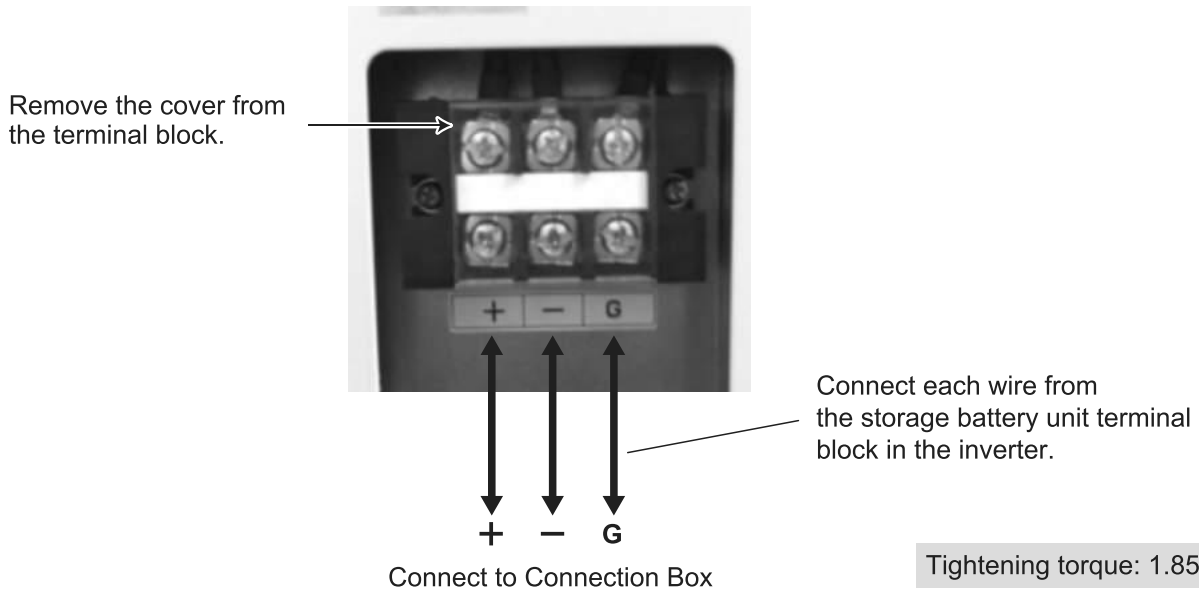

4 Connect the communication cable to the Connection Box.

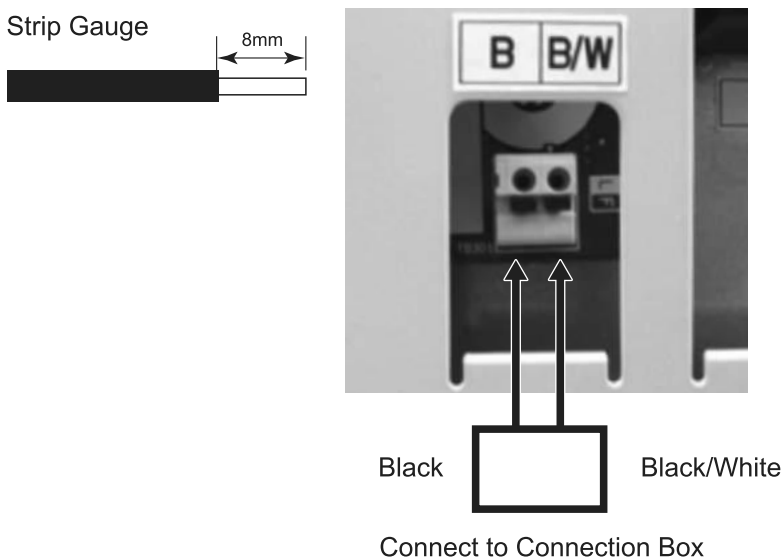

Pay attention to the polarity (wire color) of the communication cables from the communication terminal block of the storage battery unit to the Connection Box.

5 Pass the connected wires and communication cables through the clamp.

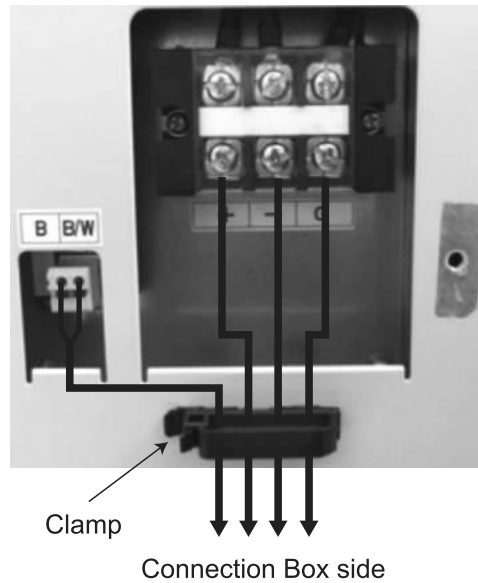

Release the clamp lock and pass each wire and cable through the clamp.

* Install the wiring cover back and ensure the wiring area is secured.

Confirmation the following items after installation is completed

1 Operation of the storage battery unit alone cannot be confirmed without the Hybrid Solar Inverter.

Confirm operation by referring to the Installation Manual of the [Home-use] Hybrid Solar Inverter (5.5 kW) (for Outdoor Installation).

2 Reattach the wiring cover in the reverse order in which it was removed. (See Step 1 on Page 8.)

Tightening torque: 1.85 to 2.05 Nm

3 Operation of the storage battery unit alone cannot be confirmed without the Hybrid Solar Inverter.

Lock the casters at the front bottom of the storage battery unit with the stoppers. (2 locations)

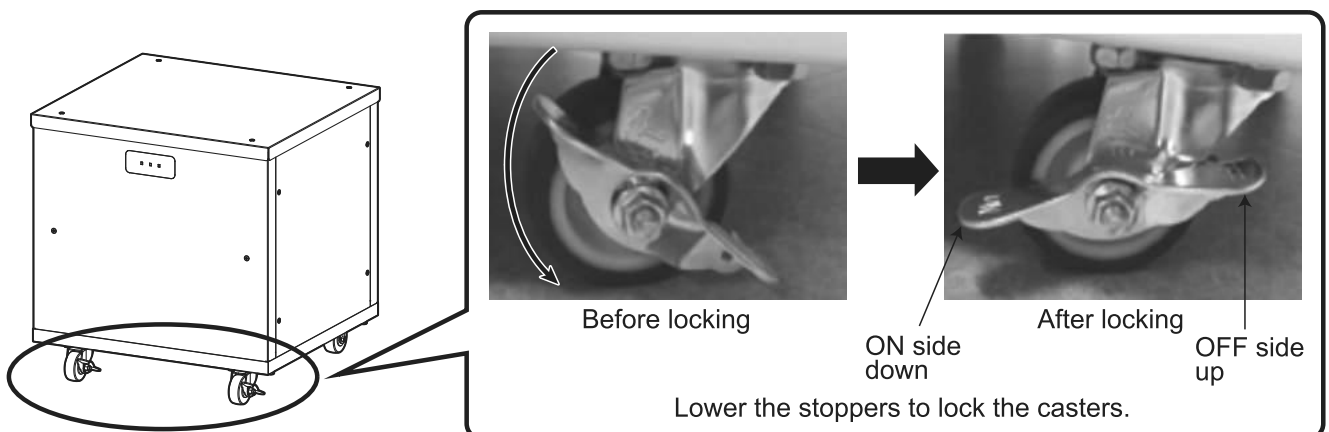

4 Operation of the storage battery unit alone cannot be confirmed without the Hybrid Solar Inverter.

To restrict to move, attach the holder onto front casters. The holders are included in the package.

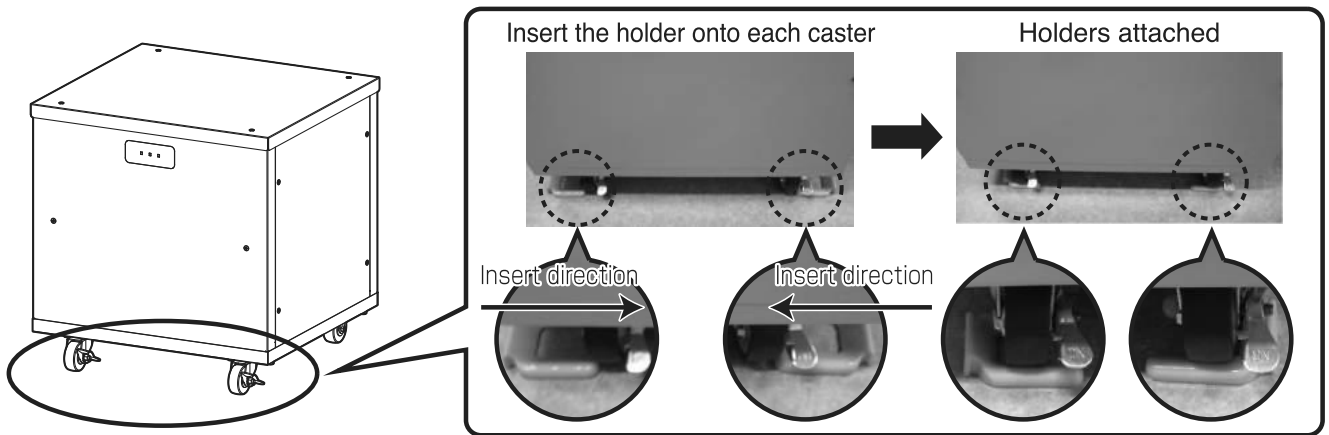

Specifications

| Item | Specification |
|-----------------------------------|--|
| Max. input (charging) current | 16.5 A |
| Max. output (discharging) current | 26.0 A |
| Rated input/output voltage | 86.4V DC |
| Rated capacity | 114.48 Ah |
| Battery Type | Lithium ion |
| Nominal capacity | 9.89 kWh |
| Required Charging Time | Approx. 8 hr (At 25°C, uncharged state) * |
| Cooling method | Natural air-cooled |
| Dimensions | W580 x H600 x D551.5 mm (22 53/64 x 23 5/8 x 21 23/32 in.) |
| Weight | About 110 kg (3880 oz.) |
| Working surrounding temperature | 0°C to 40°C (32°F to 104°F) |
| Working surrounding humidity | Max. 85% (No condensation) |
| Installation site | Indoors |

* The actual charging time will vary according to conditions of use and the age of the equipment.

FCC Compliance

Notes

This equipment has been tested and found to comply with the limits for a Class B digital device, pursuant to part 15 of the FCC Rules. These limits are designed to provide reasonable protection against harmful interference when the equipment is operated in a residential installation. This equipment generates, uses, and can radiate radio frequency energy and, if not installed and used in accordance with the instruction manual, may cause harmful interference to radio communications. Operation of this equipment in a residential area is likely to cause harmful interference in which case the user will be required to correct the interference at his own expense.

